

外球面轴承,轴承座单元

两螺栓法兰式 轴承座单元 铸铁轴承座-FLCTEY17

参数信息:

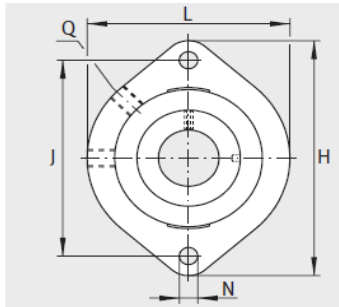

GLCTE

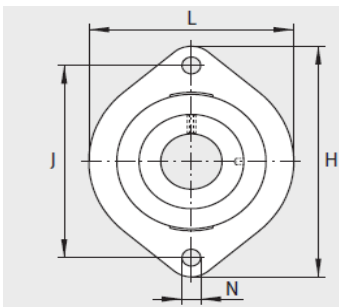

FLCTE、FLCTEY

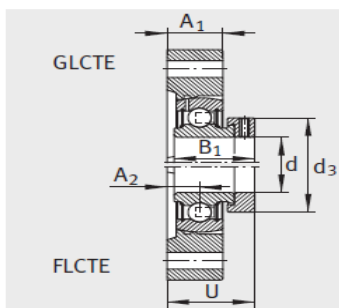

GLCTE、FLCTE

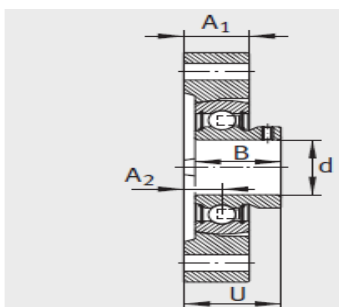

FLCTEY

型号:

单元: FLCTEY17

轴承座: GG.LCTE03

外球面球轴承: AY17-NP
P-B

质量 kg: 0.26

尺寸:

d: 17

L: 58.7

H: 81

A: 15

N: 6.6

B: 22

B: -

J: 63.5

A: 8.4

Q: -

d max.: -

U: 24.4

基本额定载荷:

动载荷 N: 9800

静载荷 N: 4750

